

The Veritas® Inlay Cutter Head is used with the Veritas® Router Plane to score both sides of a shallow groove that will accept purfling, banding or stringing. The inlay cutter head includes an assortment of steel and plastic shims so that the two spring steel blades can score grooves from 1/16" or 1mm to just under 15/32" or 12mm wide.

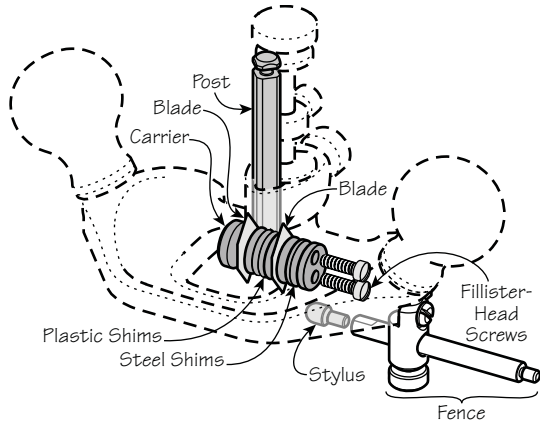

**Figure 1: Components of the inlay cutter head.**  
(Router plane not included.)









The router plane/inlay cutter assembly can be used free hand in the middle of a

workpiece, but it is more common to guide the cutter with a fence. When used with the optional fence, the router plane/inlay cutter assembly can score both sides of a shallow groove parallel to a straight edge. For following curved edges with a constant offset, the brass stylus that is included with the inlay cutter head can be threaded into the fence rod.

### Shim Stack Set-Up

**⚠ Caution:** Be aware that the blades are sharp; careless handling can result in serious injury.

**Table 1: Blades and Shims Included**

Item	Thickness (in)	Thickness (mm)	Quantity
Blade 	0.020	0.5	2
Orange Plastic 	0.002	0.05	5
Purple Plastic 	0.005	0.13	5
Blue Plastic 	0.010	0.25	5
Black Plastic 	0.020	0.5	5
1mm Steel 	0.040	1	1
2mm Steel 	0.080	2	1
3mm Steel 	0.120	3	1

To score a shallow groove of a specific width, you will need to determine which shims are needed between the blades. Due to the limits of manufacturing, some shims will not be the exact nominal size noted. **Table 2** lists starter sets for common widths. Once you have set up the stack of blades and shims, measure the overall width and adjust as required.

**Table 2: Shim Stack Starter Sets**

Size	in	mm	Shim Stack
1mm	0.039	1	None (Blades Only)
1/16	0.063	1.59	Black + 2 Orange
2mm	0.079	2	1mm
3/32	0.094	2.38	1mm + 3 Purple
3mm	0.118	3	2mm
1/8	0.125	3.18	2mm + Purple
5/32	0.156	3.97	2mm + 3 Blue + 3 Orange
4mm	0.157	4	2mm + 3 Blue + 4 Orange
3/16	0.188	4.76	3mm + Black + 4 Orange
5mm	0.197	5	3mm + 3 Blue + 4 Orange
7/32	0.219	5.56	3mm + 3 Black
6mm	0.236	6	3mm + 1mm + Black + 3 Purple
1/4	0.250	6.35	3mm + 2mm + Blue
7mm	0.276	7	3mm + 2mm + Black + 3 Purple
9/32	0.281	7.14	3mm + 2mm + 1mm + Orange
5/16	0.313	7.94	3mm + 2mm + 1mm + 3 Blue + Orange
8mm	0.315	8	3mm + 2mm + 1mm + Black + 3 Purple
11/32	0.344	8.73	3mm + 2mm + 1mm + 3 Black + Purple
9mm	0.354	9	3mm + 2mm + 1mm + 3 Black + 3 Purple
Max.	0.465	11.8	3mm + 2mm + 1mm + 5 Black + 5 Blue + 5 Purple + 5 Orange

Both fillister-head screws are required to secure the blades and shims to the carrier, but assembling the stack can be tricky. Follow these steps for trouble-free assembly.

1. Disassemble the stack by removing both screws.
2. Insert one of the screws into the **carrier side**, as shown at left in **Figure 2**. The screw will support the blades and shims as they are stacked together.
3. Starting and ending with a blade (bevel in), slide each component of the stack onto the exposed screw.
4. Insert the second screw into the **blade side** (as shown in the center of **Figure 2**) to fasten the stack to the carrier.
5. Check the width of the stack with calipers and make any necessary adjustments.
6. Remove the first screw and reinstall it in the same orientation as the second screw.
7. Check to make sure the blades project the same amount, then tighten the screws.

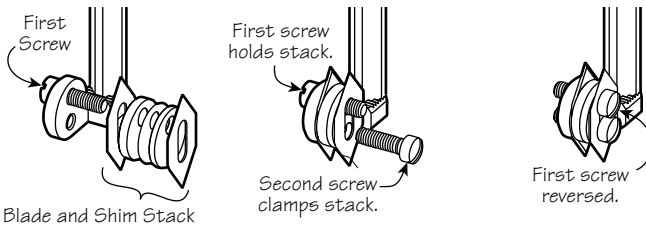

**Figure 2: Assembling the cutter stack.**

## Mounting the Inlay Cutter Head

Mount the inlay cutter head (inboard or outboard) in the router plane in the same manner as you would mount a standard router plane blade. After the inlay cutter head is installed, retract it enough to prevent the blades from projecting beyond the sole of the plane. Retracting the inlay cutter is an important habit to develop, as the blades are small and easily damaged.

## Scoring Grooves

For scoring straight grooves, install the optional fence. For scoring grooves along a curved edge, thread the stylus into the fence rod (as shown in **Figure 3** inset). For scoring freehand grooves, the fence is not required.

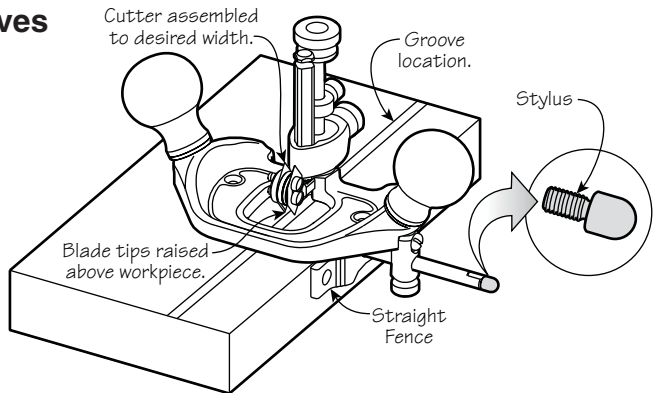

**Figure 3: Set-up for scoring straight grooves.**

It is extremely difficult to chase a previously scored pair of cuts with this tool, so it is best to score the full groove depth in a single pass; however, since the full depth is usually only about 20 thou (0.5mm), this is quite manageable.

To set the cutting depth, slowly increase the projection of the blades and test on a scrap piece of the same material. A pull stroke allows you to see where the cutter is **before** it has scored your workpiece.

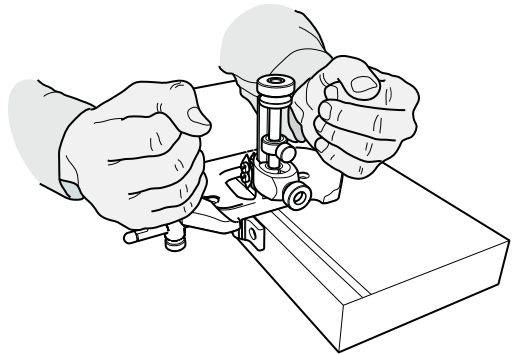

**Figure 4: Using the inlay cutter accessory with the optional fence.**

Switch to a standard router plane blade that matches the width of the desired groove, adjust the depth of cut to match the depth of the scored lines, then hog out the waste between the scored lines.

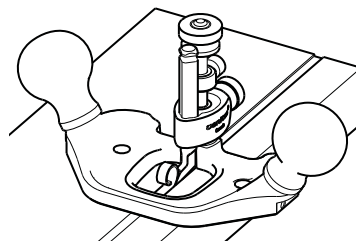

**Figure 5: Hogging out the waste between the scored lines with a standard router plane blade.**

If you need a deeper groove, or are working in dense woods such as maple, you can creep up on the final depth using an alternative technique. Space the cutters about 0.040" to 0.060" (1mm to 1.5mm) closer together than the final width of your groove. Keeping the cutters centered between the final groove location, alternately score and hog out the waste, each time increasing the cutting depth but not the width. The cutters will drift slightly on subsequent passes, resulting in rough or torn edges. This will not matter as the last step is to increase the spacing to the final width and pare a shaving off both sides of the rough groove at the full depth. This technique is illustrated in **Figure 6**.

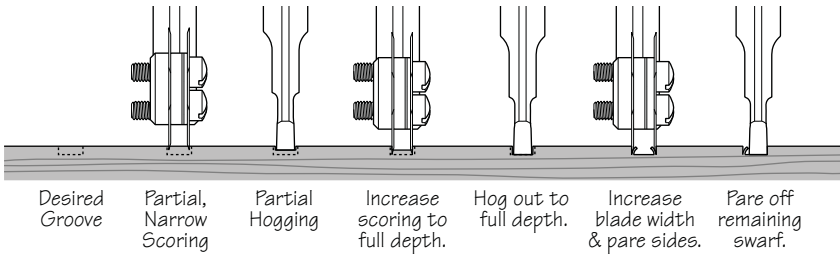
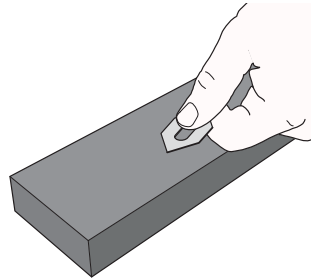

**Figure 6: Cutting a progressively deeper groove.**

## Sharpening

To extend the usable life of the blades, each has four bevelled edges. Eventually, the spring steel blades will need to be sharpened.

Remove both blades from the carrier, and by hand, push each bevel across an 800x or 1000x stone. To preserve the symmetry of the blades and ensure uniform wear, use the same number of strokes for each bevel. Five is usually enough.



**Figure 7: Sharpening the blades.**

These blades have been ground to a uniform thickness; they should **not** be lapped flat. Not only will lapping change their thickness, making them more prone to bending, but it will also wear away the bevels at different rates, making alignment difficult.

## Accessories

- 05P38.07** Optional Fence
- 05K11.10** Replacement Slicing Blade

**veritas**® Tools Inc.

814 Proctor Avenue 1090 Morrison Drive  
 Ogdensburg NY 13669-2205 Ottawa ON K2H 1C2  
 United States Canada

customerservice@veritastools.com  
[www.veritastools.com](http://www.veritastools.com)